



|| Jai Sri Gurudev ||  
**S J C Institute of Technology, Chickballpur**  
**Department of Civil Engineering**  
**CO-PO and CO-PSO Mapping**

Name of the staff: Dr.G.Narayana, Ms Sushma M.

Subject: Concrete Technology      Sub code: 18CV44      Semester: IV

**Course Objectives:**

1. In selection of materials, design and supervision of various type of concrete mix proportioning.
2. Illustrate proportioning of different types of concrete mixes for required fresh and hardened properties using professional codes.
3. Identify the various properties of hardened concrete, its behavior, strength, various tests, its durability, effect of creep as well as shrinkage on strength of hardened concrete.
4. To gain knowledge about plastering, painting, RMC, FRC, LWC.
5. Design of concrete for the proper mix Proportion

**Course Outcomes:** At the end of the course students should be able to:

CO1	Identify the functional role of ingredients of concrete
CO2	Apply fundamental knowledge in the fresh and hardened properties of concrete
CO3	Demonstrate Properties, failure modes & techniques of measuring the Non-Destructive Testing of structural concrete
CO4	Develop an awareness about utilization of waste materials as novel innovative materials for use in concrete
CO5	Design a concrete mix which fulfils the required properties for fresh and hardened concrete

**Programme Specific Outcomes (PSO's)**

After Successful completion of B.E programme in Civil Engineering, the students will be able to:

**PSO1:** Apply Civil Engineering knowledge in analysis, design, laboratory investigations and construction aspects.

**PSO2:** Solve problems in various fields of Civil Engineering with appropriate construction materials and technology.

CO-PO Mapping														
	PO1	PO2	PO3	PO4	PO5	PO6	PO7	PO8	PO9	PO10	PO11	PO12	PSO1	PSO2
CO1	2	-	2	-	-	1	-	-	-	-	-	1	1	-
CO2	3	-	-	-	-	1	-	2	-	-	-	1	-	1
CO3	2	2	-	1	-	1	-	2	-	-	-	1	2	1
CO4	2	-	-	1	1	1	-	3	-	-	-	1	-	1
CO5	2	2	3	1	-	1	-	3	-	-	-	1	2	1
AVG	2.2	2	2.5	1	1	1	-	2.5	-	-	-	1	1.67	1



### Justification

1. CO1-Students will identify the functional role of ingredients of concrete by the application of science and mathematics to solve engineering problems by the use of contextual knowledge of environmental science for lifelong learning
2. CO2-Student will apply the fundamental knowledge of science to analyse the fresh and hardened properties of concrete as per code specification for life long usage.
3. CO3-Student will demonstrate the properties and failure modes of concrete by the application of basic science for the environmental sustainability.
4. CO4-Create the awareness among the students regarding utilization of waste materials and also novel innovative materials for the use of concrete by the application of science as eco-friendly
5. CO5-Students will able to design the different concert mix design to fulfill the requirements of fresh and hardened state by the use of sound knowledge of science for environmental sustainability by the usage of professional code specification.

### Signature of Committee members

1. Dr. G Narayana

2. Ms. Sushma M

3. Mrs. Bhavya S

4. Mr. Suhas K B

Signature of the NOD

SICIT/NBA/ CO-PO-PSO REPT/ 2019-20	 <b>S J C INSTITUTE OF TECHNOLOGY</b> Chlckballapur - 562 101 Department of Civil Engineering						
Course Title	Concrete Technology					Course Code	C212
Subject Code	17CV44	Semester	4	Section	A & B	Emp.ID	1909
Faculty Name	Sushma M					No.students	114

**Summary of CO attainments of Sub: 17CV44 Based on (AVERAGE-TYPE-1) Academic Year:2019-20**

CO	CID_CO	CIE			SEE			CES			TOT_Attainment		
		S_AT	T_ST	ATN	S_AT	T_ST	ATN	S_AT	T_ST	ATN	ATN	%	Status
CO1	C214.1	271	114	2.4	255	114	2.2	294	114	2.6	2.3	78	YES
CO2	C214.2	182	114	1.6	255	114	2.2	287	114	2.5	2	67	YES
CO3	C214.3	246	114	2.2	255	114	2.2	287	114	2.5	2.2	75	YES
CO4	C214.4	300	114	2.6	255	114	2.2	286	114	2.5	2.4	80	YES
CO5	C214.5	206	114	1.8	255	114	2.2	290	114	2.6	2.1	70	YES

**Summary of PO attainments of Sub: 17CV44 Based on (AVERAGE-TYPE-1) Academic Year:2019-20**

PO Number	1	2	3	4	5	6	7	8	9	10	11	12
Direct ATNT(D)	2.14	2.11	2.13	2.2	2.38	2.17		2.15				2.17
Indirect ATNT(ID)	2.54	2.55	2.6	2.53	2.5	2.54		2.53				2.54
Total-ATNT	2.18	2.15	2.18	2.23	2.4	2.2		2.19				2.2
ATNT TO SCALE	1.6	1.43	1.82	0.74	0.8	0.8		1.83				0.73

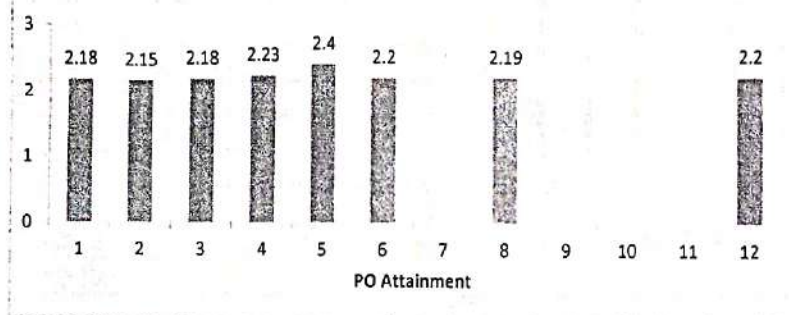

**Summary of PSO attainments in Year:2019-20**

PSO Number	1	2	3	4
Direct ATNT(D)	2.15	2.13		
Indirect ATNT(ID)	2.56	2.53		
Total-ATNT	2.18	2.18		
ATNT TO SCALE	1.21	0.73		

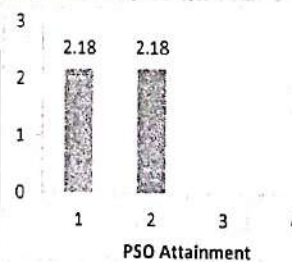



Department : CIVIL ENGINEERING						
LESSON PLAN						
CLASS: 4 <sup>th</sup> SECTION: B	FACULTY: Dr G.NARAYANA	SUBJECT: Concrete Technology		SUB CODE: 17CV44		
<b>OBJECTIVE:</b> The objectives of this course is to make students 1. Recognize the importance of material characteristics and their contributions to strength development in Concrete 2. Proportion ingredients of Concrete to arrive at most desirable mechanical properties of Concrete. 3. Ascertain and measure engineering properties of concrete in fresh and hardened state which meet the requirement of real time structures.						
<b>PREREQUISITE(s):</b> Basic Knowledge on building Materials (cement, fine aggregates and coarse aggregates)						
<b>EXPECTED OUTCOME: After studying this course, students will be able to:</b> <b>CO 1:</b> Identify the functional role of ingredients of concrete and apply this knowledge to mix design philosophy <b>CO 2:</b> Acquire and apply fundamental knowledge in the fresh and hardened properties of concrete <b>CO 3:</b> Evaluate the effect of the environment on service life performance, properties and failure modes of structural concrete and demonstrate techniques of measuring the Non-Destructive Testing of concrete structure <b>CO 4:</b> Develop an awareness of the utilization of waste materials as novel innovative materials for use in concrete <b>CO 5:</b> Design a concrete mix which fulfills the required properties for fresh and hardened concrete						
<b>IT IS BASIC SUBJECT FOR:</b> Advanced concrete Technology						
<b>SUBJECT APPLICATIONS:</b> Batching, Mixing and placing of concrete, designing of concrete mix for various proportion						
Sl no.	TOPIC	PLANNED		ACTUAL		REMARKS
		No of Hours	Date	No of Hours	Date	
<b>MODULE 1</b>	<b>CONCRETE INGREDIENTS</b>					
	Introduction on Subject	01	04/02/19	01	04/02/19	completed
	Cement manufacturing process, Steps to reduce carbon footprint	01	06/02/19	01	06/02/19	shown ppt cement manufacturing
	chemical composition and their importance,	01	07/02/19	01	07/02/19	completed
	hydration of cement, Types of cement,	01	08/02/19	01	08/02/19	completed
	Testing of cement	01	11/02/19	01	11/02/19	apparatus shown in class
	Coarse aggregate: Importance of size, shape and texture. Grading and blending of aggregate.	01	13/02/19	01	13/02/19	shown ppt
	Testing on aggregate, requirement. Recycled aggregates.	01	14/02/19	01	14/02/19	completed
	Fine aggregates functions, requirement, Alternatives to River sand,	01	15/02/19	01	15/02/19	completed
	M-sand introduction and manufacturing, Water - qualities of water,	01	18/02/19	01	18/02/19	completed



	introduction on Chemical admixtures Plasticizers, accelerators, retarders and air entraining agents.	01	21/02/19	01	21/02/19	completed
	Introduction on Mineral admixtures – Pozzolanic and cementitious materials Fly ash, GGBS,,silica fume,ricchusk as	01	22/02/19	01	22/02/19	completed
<b>MODULE 2</b>	<b>FRESH CONCRETE</b>					
	Workability-factors affecting workability, Measurement of workability–slump, Compaction factor	01	25/02/19	01	25/02/19	completed
	Measurement of workability–Vee-Bee Consistometer tests, flow tests.	01	27/02/19	01	27/02/19	ppt shown
	Segregation and bleeding, Process of manufacturing of concrete- Batching, Mixing,	01	28/02/19	01	28/02/19	completed
	Transporting procedure ,Placing and Compaction	01	01/03/19	01	06/03/19	completed
	Curing – Methods of curing-water curing, membrane curing, steam curing	01	06/03/19	01	06/03/19	complete
	Curing – Methods of curing accelerated curing, self-curing etc.	01	07/03/19	01	07/03/19	complete
	Good and Bad practices of making and using fresh concrete	01	08/03/19	01	07/03/19	com
	Effect of heat of hydration during mass concreting at project sites.	01	11/03/19	01	01/03/19	complete
	Tutorial-1	01	13/03/19	01	13/03/19	complete, don't test gen
	Flip classes	01	13/03/19	01	09/03/19	Quiz conducted
<b>1<sup>st</sup> INTERNALS March 14<sup>th</sup>, 15<sup>th</sup>, 16<sup>th</sup></b>						
<b>MODULE 3</b>	<b>HARDENED CONCRETE</b>					
	Factors influencing strength, W/C ratio, gel/space ratio,	01	18/03/19	02	15/03/19 20/03/19	compr
	Maturity Concept, Testing of hardened concrete	01	20/03/19	01	25/03/19	compr
	Creep –factors affecting creep. Shrinkage of concrete.	01	21/03/19	01	25/3/19	—
	plastic shrinking and drying shrinkage,Factors affecting shrinkage	01	22/03/19	01	29/03/19	—
	Definition and significance of durability, Internal and external factors influencing durability	01	25/03/19	01	1/04/19	—
	Mechanisms- Sulphate attack – chloride attack, carbonation,	01	27/03/19	01	1/04/19	—
	freezing and thawing ,Corrosion, Durability requirements as per IS-456	01	28/03/19	01	03/04/19	—
	In-situ testing of concrete, Penetration and pull out test,	01	29/03/19	01	5/4/19	—



	Rebounds hammer test, ultrasonic pulse velocity, core extraction, Principal, applications and limitations.	01	01/04/19	01	5/04/19	Completed
	Revision	01	03/04/19	01		
<b>MODULE 5</b>	<b>SPECIAL CONCRETES</b>					
	RMC- manufacture as per QCI-RMCPCS	01	04/04/19	01	5/04/19	Completed
	Properties, advantages and disadvantages of Rmc.	01	05/04/19	01	10/5/19	Completed
	Self-Compacting concrete- concept, materials, Test on SCC	01	08/04/19	01	11/04/19	Completed
	Test on SCC, properties, application, typical self-Compacting concreting mix	01	10/04/19	01	12/15/19	Completed
	Fibers types, properties, application of FRC.	01	11/04/19	01	22/05/19	Completed
	Light weight concrete-material properties and types	01	12/04/19	01	25/5/19	Completed
	Tutorial-2	01	15/04/19	01	12/04/19	Completed
2 <sup>nd</sup> INTERNALS Apr 16 <sup>th</sup> , 18 <sup>th</sup> , 20 <sup>th</sup>						
	Typical light weight concrete mix and applications	01	22/04/19	01	26/04/19	Completed
	Revision	01	24/04/19			
<b>MODULE 4</b>	<b>CONCRETE MIX PROPORTIONING</b>					
	Concept of Mix Design with admixtures	01	25/04/19	01	02/05/19	Completed
	Concept of Mix Design without admixtures	01	26/04/19	01	03/5/19	Completed
	variables in proportioning and Exposure conditions	01	29/04/19	01	3/5/19	Completed
	Selection criteria of ingredients used for mix design,	01	02/05/19	01	06/5/19	Completed
	Procedure of mix proportioning	01	03/05/19			
	Procedure of mix proportioning	01	06/05/19			
	Numerical Examples of Mix Proportioning using IS-10262	01	08/05/19	01	08/5/19	Completed
	Numerical Examples of Mix Proportioning using IS-10262	01	09/05/19	01	09/05/19	Completed
	Numerical Examples of Mix Proportioning using IS-10262	01	10/05/19	01	13/05/19	Completed
	Tutorial 3	01	11/05/19	01	10/05/19	Completed
3 <sup>rd</sup> INTERNALS May 13 <sup>th</sup> , 14 <sup>th</sup> , 15 <sup>th</sup>						
	Flip classes	01	16/05/19			
	Revision	01	17/05/19			
	Revision	01	18/05/19			

Assignments and Mini Project

Assignment - I	module - 1 & 2 Quiz conducted on 09/03/2019 in Edmodo
Submitted on:	
Assignment - II	writing assignment - 15/05/2019 [ mix design previous year paper problems ]
Submitted on:	
Assignment - III	module - 1, 2, 3 Quiz conducted on 2/05/2019, in Edmodo
Submitted on:	



Literature to be Referred for the Course:

Book Type	Code	Title & Author	Publication Information		
			Edition	Publisher	Year
Text Books	T1	M.S. Shetty, Concrete Technology - Theory and Practice Published by S. Chand and Company, New Delhi.	3 <sup>rd</sup>	S. Chand and Company,	2016
	T2	A.R. Santha Kumar, "Concrete Technology",	New Edition	Oxford University Press, New Delhi	2016
Reference Books	R1	M L Gambir, "Concrete Technology",	2nd	TATA Mc Graw Hill Education Pvt. Ltd., New Delhi	2014

Comments by Faculty:

Comments by HOD:

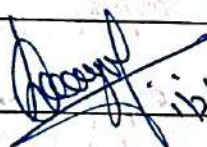
Note: Plan and execution is for 5 Modules.

Prepared by	Dr.G.NARAYANA	Reviewed by	Dr.G.NARAYANA	Approved by	Dr. G.NARAYANA
Date & sign	 12/19	Date & sign		Date & sign	 12/19



|| JAI SRI GURUDEV ||

**S J C Institute of Technology**

Chickballpur



DEPARTMENT OF CIVIL ENGINEERING

# CONCRETE TECHNOLOGY

## MODULE:2

### FRESH CONCRETE

# FRESH CONCRETE

- Fresh or plastic concrete is a freshly mixed material which can be **mould into any shape**
- It is a concrete mixed and ready for placement in the formwork
- Properties of fresh concrete
  1. Workability of concrete
  2. Segregation of concrete
  3. Bleeding of concrete
  4. Hydration of concrete

# WORKABILITY

- Workability of concrete is defined as that property of fresh concrete which determines **the ease and homogeneity**.
- Workability is the ease with which concrete is Transported, placed in the formwork and compacted and finished without any segregation is called workability.
- It is composed of two parameter
  1. Consistency
  2. Homogeneity
- Consistency is ability of fresh concrete to flow
- Homogeneity is the stable /uniform distribution of ingredients of concrete

# FACTORS AFFECTING WORKABILITY

- Water content
- Mix proportion
- Size of aggregate
- Shape of aggregate
- Surface texture of aggregate
- Grading of aggregate
- Use of admixture
- Temperature

## Water content/water-cement ratio

- Water cement ratio is one of the **most important factor** which influence the concrete workability.
- Generally, a water cement ratio of **0.45-0.6 is used** for good workable concrete without the use of any admixture.
- The **strength and quality of concrete** is depends upon this ratio
- Higher the water /cement ratio higher will the water content per volume of concrete and concrete will be more workable

## Mix proportion

- mix proportion of concrete tell us the **ratio of fine aggregates and coarse aggregates w.r.t cement quantity**. This is called as the aggregate cement ratio of concrete.
- The **low quantity of cement** w.r.t aggregates will make the less paste available for aggregate and mobility of aggregate is restrained
- The **more cement** is used,concrete become richer and aggregate will have proper lubrications for easy mobility or flow of aggregate(more workability)

## Size of aggregates

- **Surface area** of aggregate depends on the size of aggregates
- The aggregates with large size, the **surface area is less** compared to aggregate with small size.
- When is surface area increases the requirement of **cement quantity and water also increases** to cover up the entire surface of aggregate with paste.
- **Bigger size aggregate** will give more **workability** compare to small size aggregate.

## Shape of aggregate

- The shape of the aggregate affects the workability of concrete
- The **rounded aggregates** will be easy to mix **than elongated, angular, and flaky aggregates** due to less frictional resistance
- And also round aggregates have **less surface area** compared to elongated or irregular shaped aggregates. This will make **less requirement of water** for same workability of concrete
- **River sand and gravels are commonly** preferred for concrete as they are rounded in shape

## **Surface texture of aggregate**

- Rough textured aggregates will show poor workability and smooth or glassy textured aggregates will give better workability.

## **Grading of aggregate**

- The better the grading, the less is the void content and higher workability.

## **Use of admixture**

- The most important factor which affect workability is the use of admixture.
- Use of plasticizers and super plasticizers greatly improve the workability of concrete

## **Temperature**

- The workability decreases with the increase of temperature because, with the increase in temperature both the rate of hydration and rate of evaporation increases, hence the loss of moisture is high

# MEASUREMENT OF WORKABILITY

The following test are commonly used to measure workability

- Slump test
- Compaction factor
- Vee-bee consistometer test
- Flow test

# Slump test

- **Aim :-**
- To Determine the Consistency Of Concrete or workability of concrete
- **Principle**
- The slump test result is a measure of the behaviour of a compacted inverted cone of concrete under the action of gravity. It measures the consistency or the wetness of concrete

- **Apparatus**

- Slump cone : frustum of a cone, 300 mm (12 in) of height. The base is 200 mm (8in) in diameter and it has a smaller opening at the top of 100 mm
- Scale for measurement,
- Temping rod(steel) 15mm diameter, 60cm length.

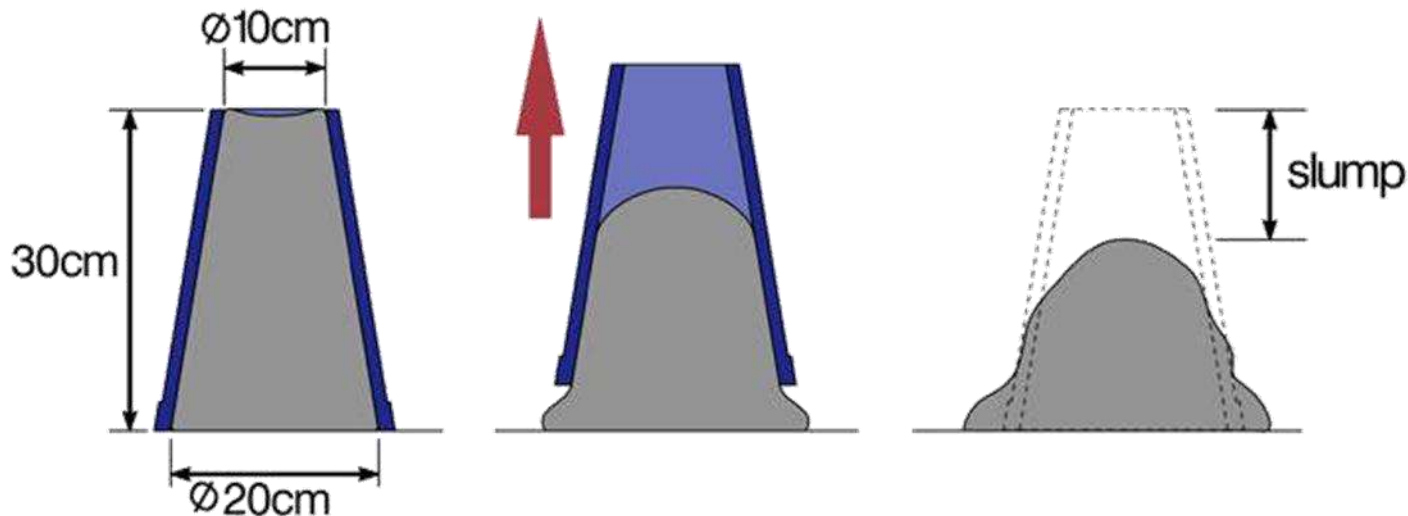

# PROCEDURE

- The internal surface of the mould is thoroughly cleaned
- The mould is placed on smooth, horizontal and non-absorbent surface
- The mould is filled with concrete in **3 layers**. Each layer tamped with **25 strokes** of tamping rod
- Then the mould is removed by lifting it slowly and carefully in a vertical direction. This allows the concrete to subside. This subsidence is referred as slump of concrete
- The difference in level between the height of the mould and that of the highest point of the subsided concrete is measured. This difference in height in mm is taken as slump of concrete

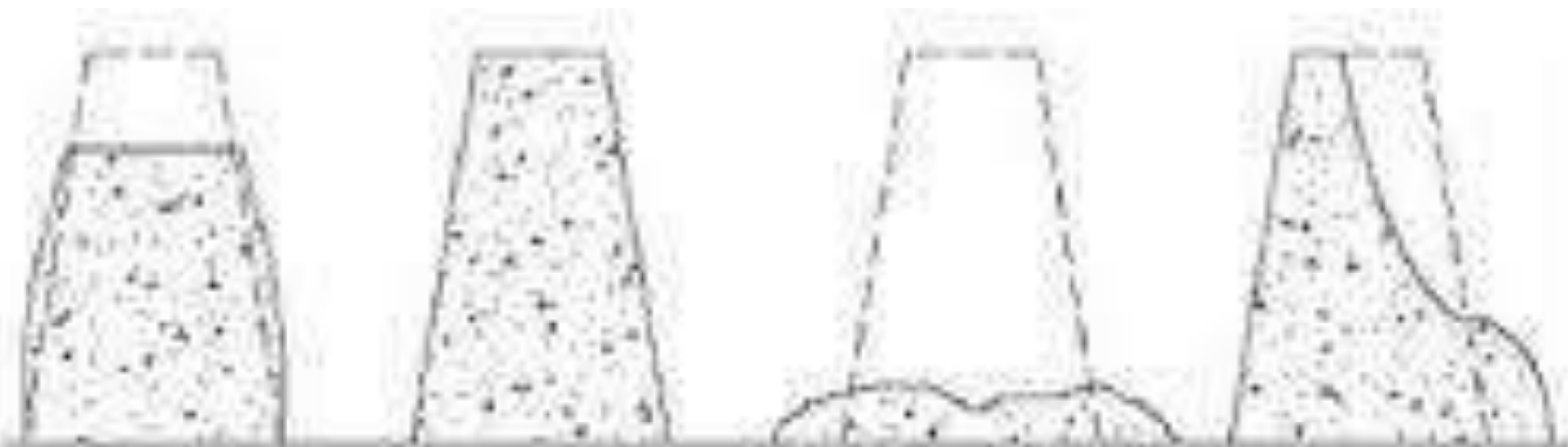

True

Zero

Collapsed

Shear

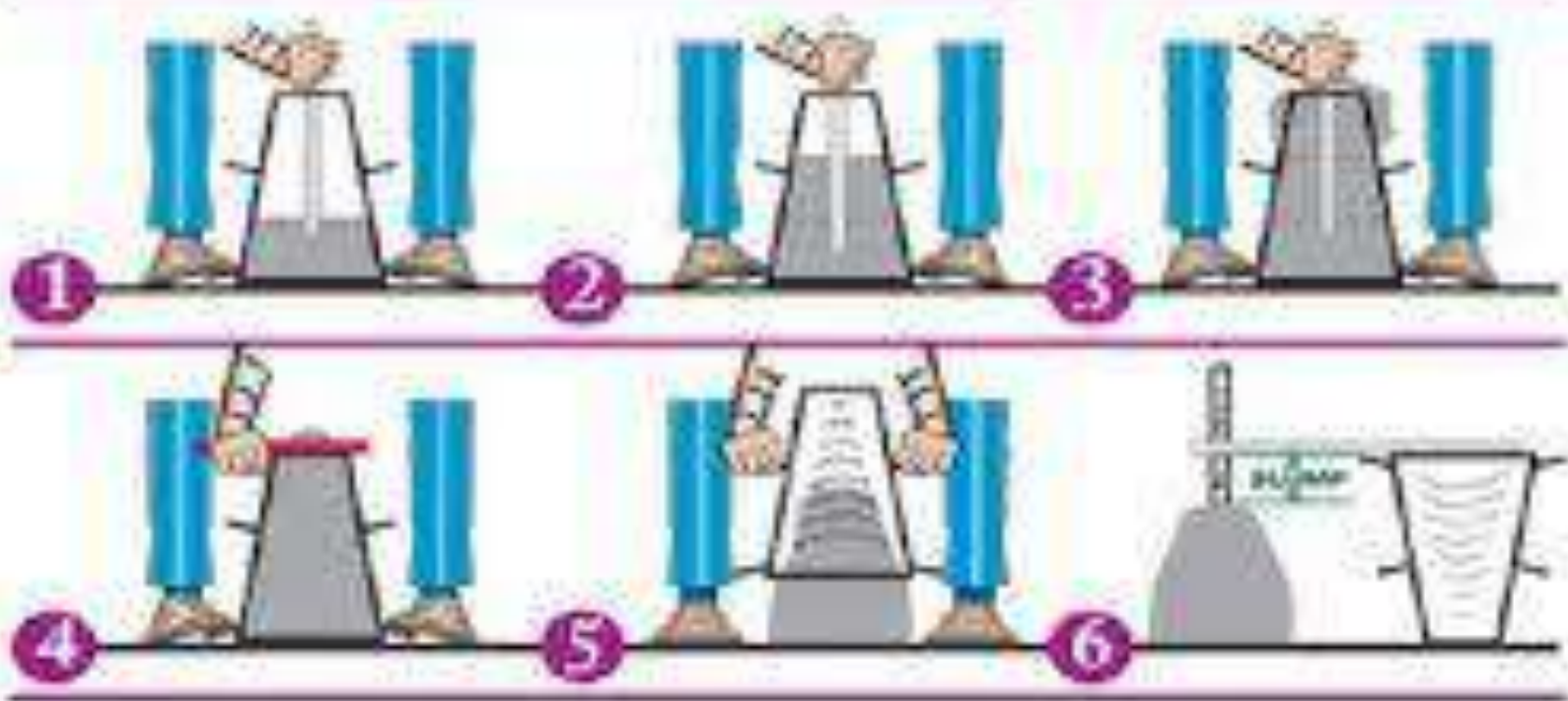

1

2

3

4

5

6

# • Types Of Slump

- The slumped concrete takes various shapes, and according to the profile of slumped concrete, the slump is termed as;
  - Collapse Slump
  - Shear Slump
  - True Slump

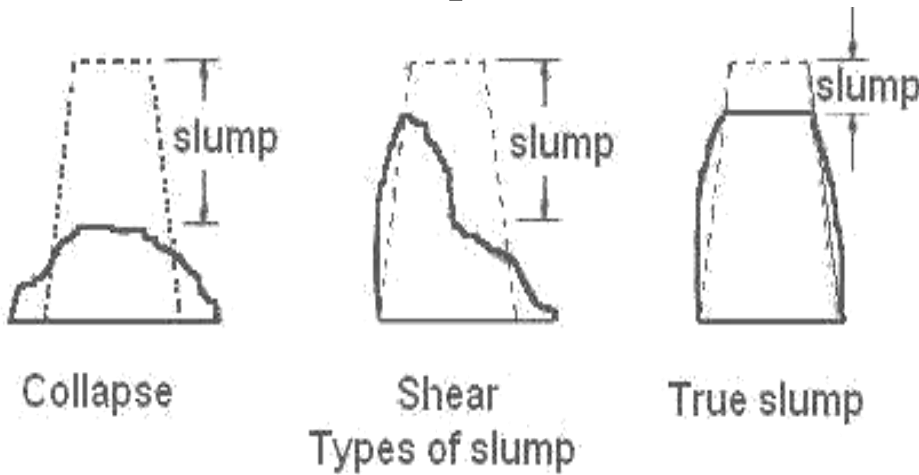

- **Types Of Slump**

- **Collapse Slump**

In a collapse slump the concrete collapses completely.

A collapse slump will generally mean that the mix is too wet or that it is a high workability mix, for which slump test is not appropriate.

- **Shear Slump**

In a shear slump the top portion of the concrete shears off and slips sideways.  
OR

If one-half of the cone slides down an inclined plane, the slump is said to be a shear slump.

- If a shear or collapse slump is achieved, a fresh sample should be taken and the test is repeated.
    - If the shear slump persists, as may the case with harsh mixes, this is an indication of lack of cohesion of the mix.

- **True Slump**

In a true slump the concrete simply subsides, keeping more or less to shape

- This is the only slump which is used in various tests.
- Mixes of stiff consistence have a Zero slump, so that in the rather dry range no variation can be detected between mixes of different workability.

Degree of workability	Slump (mm)	Use for which concrete is suitable
Very low	0 - 25	Very dry mixes; used in road making. Roads vibrated by power operated machines
Low	25 - 50	Low workability mixes; used for foundations with light reinforcement. Roads vibrated by hand operated Machines
Medium	50 - 100	Medium workability mixes; manually compacted flat slabs using crushed aggregates. Normal reinforced concrete manually compacted and heavily reinforced sections with vibrations
High	100 - 175	High workability concrete; for sections with congested reinforcement. Not normally suitable for vibration

# FLOW TEST

## Aim :-

- The flow table test or flow test is a method to determine the consistence of fresh concrete.

## Principle

- This test is giving us the **ability of concrete to flow** under the gravitational force when poured and compacted within the cone and suddenly lifted up

- **Equipment**

- Flow table with a grip and a hinge, 70 cm x 70 cm.
- Abrams cone, open at the top and at the bottom - 30 cm high, 17 cm top diameter, 25 cm base diameter
- Water bucket and broom for wetting the flow table.
- Tamping rod, 60 cm height
- Scale for measurement



- **Conducting**

- The flow table is wetted.
- The cone is placed on the flow table and filled with fresh concrete in **two layers, each layer 25 times tamp** with tamping rod.
- The cone is lifted, allowing the concrete to flow.
- The flow table is then lifted up several centimetres and then dropped, causing the concrete flow a little bit further.
- After this the diameter of the concrete is measured **in a 6 different direction** and take the average.

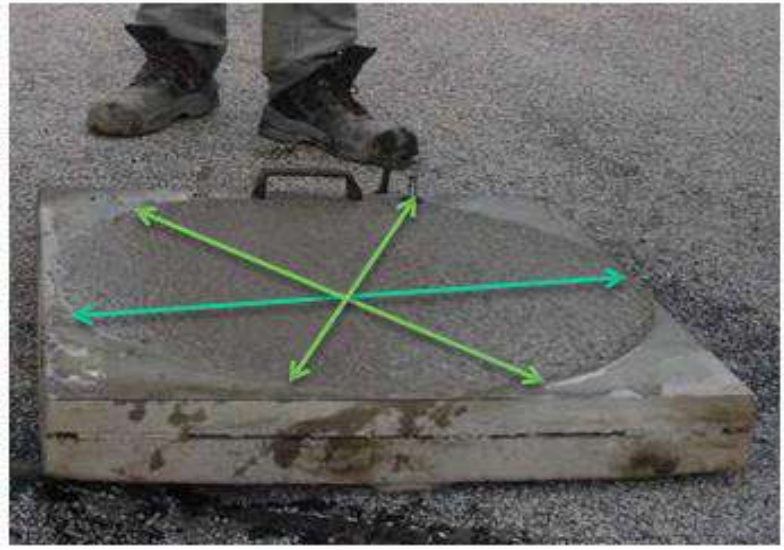

# COMPACTION FACTOR TEST

- **Aim**

- To measure the degree of compaction For the standard amount of work and thus offer a direct and reasonably reliable assessment of the workability Of concrete .

- **Principle**

- the test require measurement of the **weight of the partially and fully compacted concrete** and the ratio the partially compacted weight to the fully compacted weight, which is always less than one, is known as compacted factor .
- For the normal range of concrete the compacting factor lies between **0.8 - 0.92**

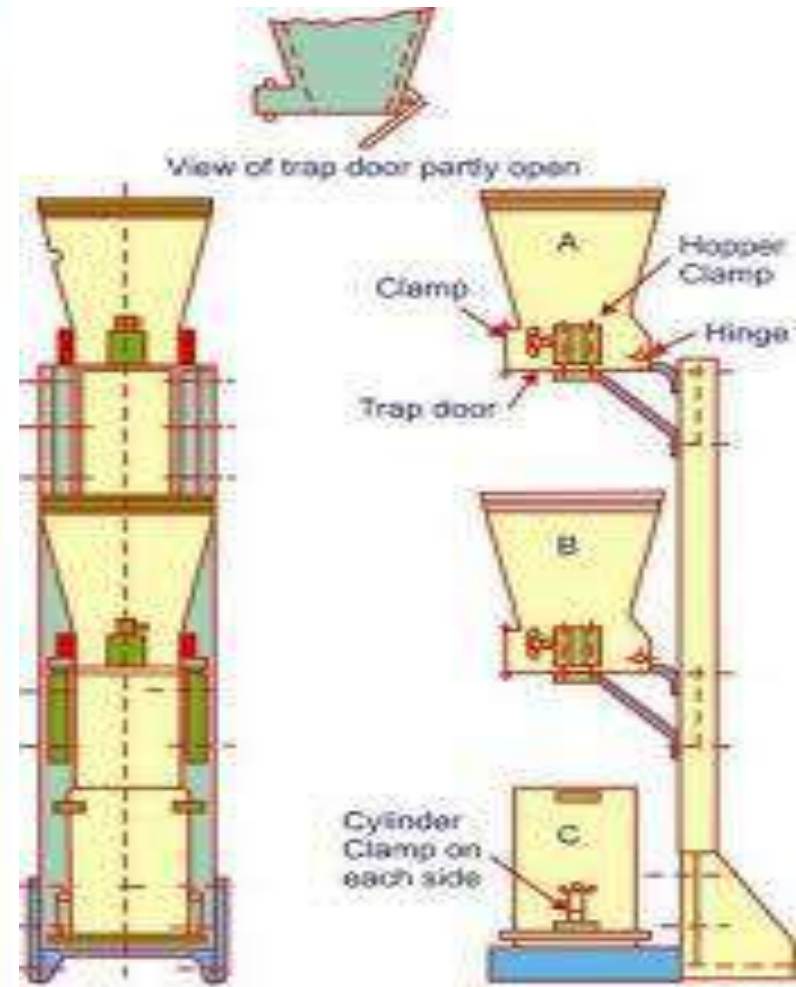
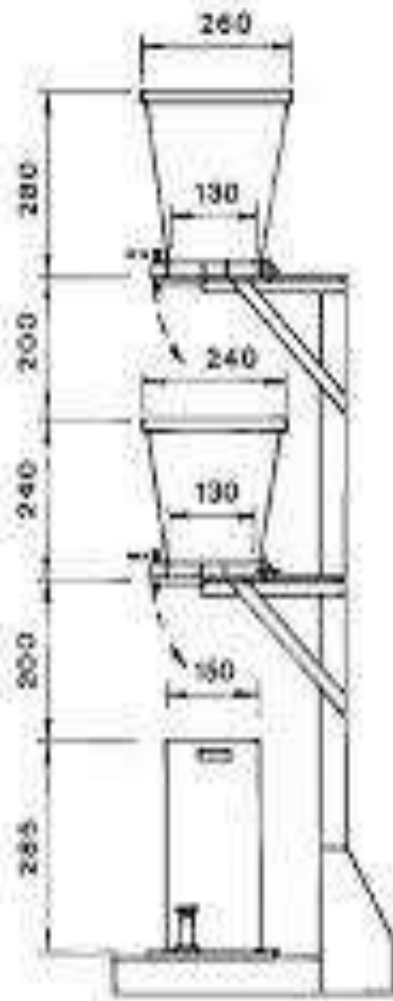

FIG. 8.3. Compaction factor test apparatus.

# COMPACTION FACTOR TEST

- In this test, the hopper 'A' is filled up with the concrete mix up to the top. by opening the trap door of hopper 'A', the concrete is allowed to fall in hopper 'B'.
- Now by opening the trap door of hopper B the concrete is allowed to fall in the cylinder C again some fixed amount of work is done on the same concrete
- The concrete thus received in the cylinder had been compacted by standard amount of work by falling through hopper-to-hopper and hopper to cylinder.
- The concrete in the cylinder is then flushed with the top of cylinder
- Let the weight of this concrete in the cylinder is  $W$
- Now the same concrete mix is poured in layers in the cylinder in specified manner and is compacted in standard manner to achieve the full compaction. Let the weight of fully compacted concrete in the cylinder is  $W_1$

## 2. Compacting factor test

(to distinguish between low slump mixes)

1. Concrete is placed in an upper
2. Dropped into a lower hopper to bring it to a standard state and then allowed to fall into a standard cylinder.
3. The cylinder and concrete weighed (partially compacted weight)
5. The concrete is fully compacted, extra concrete added and then concrete and cylinder weighed again (fully compacted weight)

Upper hopper

Lower hopper

Cylinder

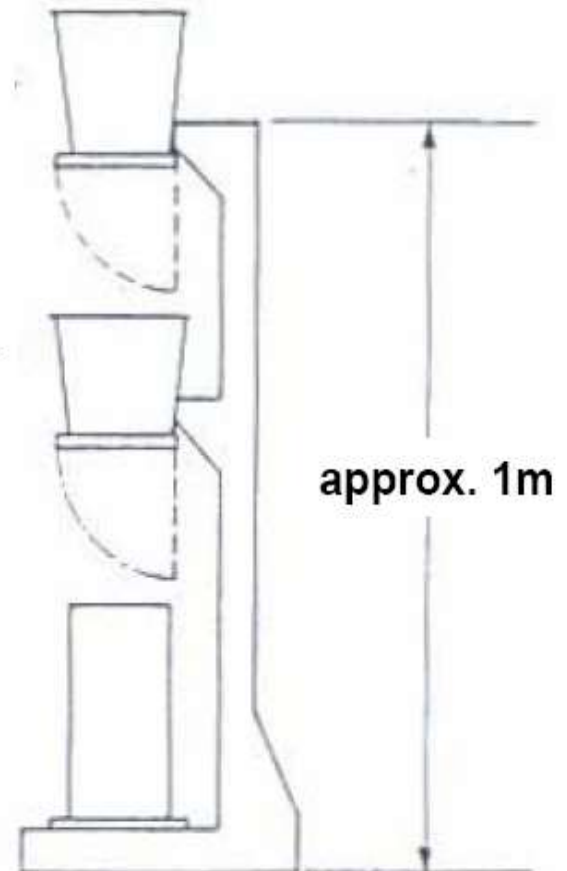

$$\text{Compacting factor} = \frac{\text{weight of partially compact concrete}}{\text{weight of fully compact concrete}}$$

Workability	Slump (mm)	C.F	Uses
Very Low	0 - 25	0.78	Roads - Pavements
Low	25 - 50	0.85	Foundations Concrete
Medium	25 - 100	0.92	Reinforced Concrete
High	100 - 175	0.95	Reinforced Concrete (High Reinforcement)

# VEE-BEE CONSISTOMETER TEST

- **Aim**

- To Measure the workability of Concrete

- **Principle**

- It is based on measuring the time (Called VEBE time) needed to transfer the shape of a concrete mix from a frustum cone to a cylinder (these shapes are standardized by the apparatus of this test), by vibrating and compacting the mix. The more VEBE time needed the less workable the mix is. This method is very useful for stiff mixes.

# Apparatus

- Cylindrical container with diameter = 240 mm, and height = 200 mm
- Mould: the same mould used in the slump test.
- Disc : A transparent horizontal disc attached to a rod which slides vertically
- Vibrating Table : 380\*260 mm, supported by four rubber shock absorbers
- Tamping Rod

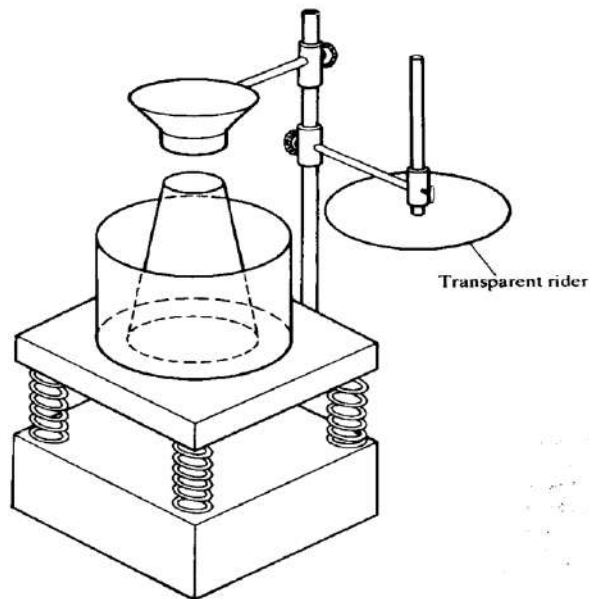

# PROCEDURE

- For carrying out the test first of all the slump test is performed by placing the **slump cone** inside the cylindrical pot
- After removing the slump cone mould the glass disc is turned and placed over the top the concrete mass.
- Now controlled vibrations are started through electric vibrator and simultaneously the stop watch is started
- The concrete is allowed to spread out in the pot.
- The vibrations are continued till the conical shape of concrete disappears and **concrete surface become horizontal**.
- The **time required** for complete remoulding of concrete (**i.e. From conical to cylindrical shape**)in seconds is expressed as the number of Vee-Bee seconds.

Very low workability	>20sec
Low workability	6-12sec
Medium workability	3-6 sec
High workability	0-3sec

# Segregation and Bleeding

From placing to final set, concrete is in a plastic, semi-fluid state.

Heavier particles (aggregates) have tendency to move down (SEGREGATION).

Mix water has a tendency to move up (BLEEDING)

- Segregation is when **the coarse and fine aggregate, and cement paste**, become separated.
- Segregation may happen when the concrete **is mixed, transported, placed or compacted**.
- Segregation makes the concrete:

**WEAKER,**

**LESS DURABLE,**

**and will leave A POOR SURFACE FINISH.**

**Causes of segregation:** Segregation takes place when

- There is too much of **water** in the mix
- There are **badly graded** aggregates(decrease in the amount of fine particles)
- Segregation is also caused by **over compaction**
- When concrete is discharged from **badly designed mixer**, concrete shows tendency of segregation
- **Leakage** of mortar from formwork
- **Too vibratory** or too long transporting method of concrete
- Segregation is also caused by dropping wet concrete from **long height.**

# Segregation on site





## To avoid segregation

- Check the concrete is not 'too wet' or 'too dry'
- The concrete should be placed as soon as possible
- By ensuring a certain minimum proportion of finer materials, proper grading of aggregate
- By restricting the height of pour
- By properly designed the amount of water to be used for mixing
- Make sure the concrete is properly mixed. It is important that the concrete is mixed at the correct speed in transit mixer for at least 2 minutes immediately prior to discharge

# Segregation of a reinforced concrete column





# BLEEDING OF CONCRETE

- **Bleeding** in fresh **concrete** refers to the process where free water in the mix is pushed upward to the surface due to the settlement of heavier solid particles such as **cement** and water. Some **bleeding** is normal but excessive **bleeding** can be problematic.



# Bleeding on site



# Effects Of Bleeding

- Due to bleeding concrete loses **its homogeneity**.
- Bleeding is responsible for causing **permeability** in concrete.
- As far as safety is concerned, water that accumulates below the reinforcing bars, reduces the **bond between the reinforcement and concrete**.
- In the process of bleeding the accumulation of water creates a water voids and reduces bond between the **aggregate and cement paste**.
- Due to bleeding **pumping ability** of concrete is reduced.
- Increase in the water-cement ratio at the top.
- The accumulation of water at the top, results in **delayed surface finishing**

# Methods Of Reducing Bleeding

- Add minimum water content in the concrete mix, use chemical admixtures to **reduce demand to water** for a required workability.
- Design the concrete mix properly **Use fly ash** or other supplementary cementitious materials.
- Using **air entraining admixtures** is very effective in reducing the bleeding.
- Add **more cement** in the mix.
- Increase the amount of **fine aggregate if sand** is coarser (fineness modulus of 2.5 to 2.8 best suited) in mix and reduce aggregate proportionally



# Stages for production of concrete:-

- BATCHING
- MIXING
- TRANSPORTING
- PLACING
- COMPACTING
- CURING
- FINISHING

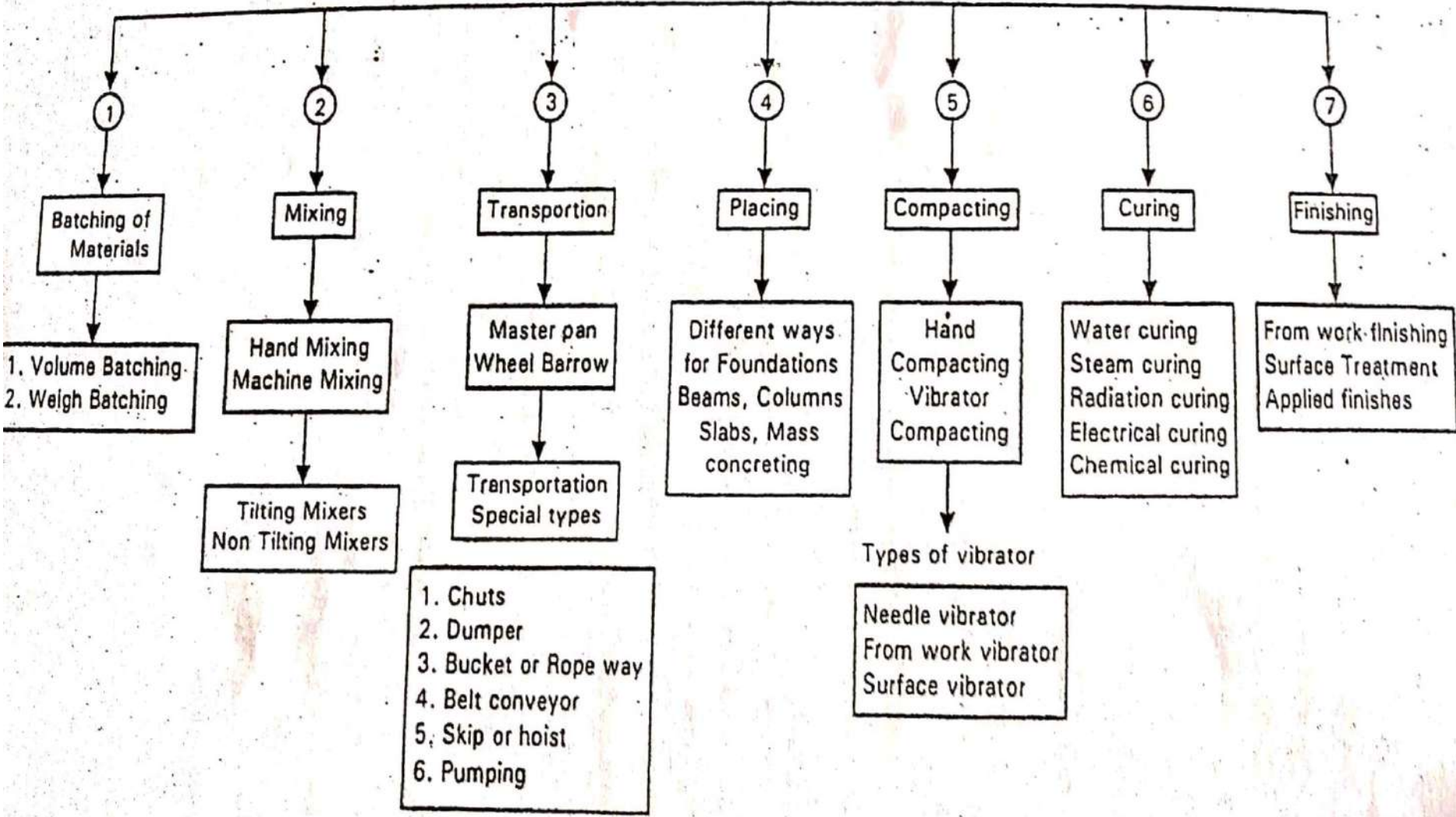

Fig. 2.9 : Flow chart for production of concrete

**BATCHIG**

## ➤ **Batching:-**

- Batching is the process of measuring concrete mix ingredients **by either mass or volume** and introducing them into the mixer.
- To produce concrete of **uniform quality**, the ingredients must be measured accurately for each batch.

Volume batching

Weight batching

## ➤ **Volume batching:-**

- This method is generally adopted for **small jobs** .
- **Gauge boxes** are used for measuring the fine and coarse aggregate.
- The volume of gauge box is equal to the **volume of one bag of cement**.

- Gauge bow are also called as FARMAS
- They can be made of timbers or steel.
- They are made generally deep and narrow
- Bottom less gauge boxes are generally avoided.
- While filling the gauge boxes the material should be **filled loosely**, **no compaction is allowed**.

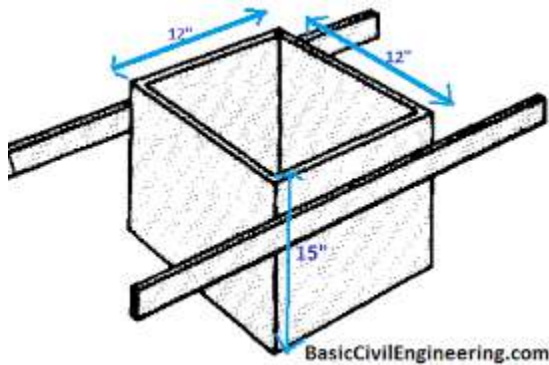

Size : 300 mm x 300 mm x 400 mm. Dimensions of A Standard measuring box : 12" X 12" x 15" = 1'X 1'X 1'3". Volumetric batching of concrete is discouraged nowadays.

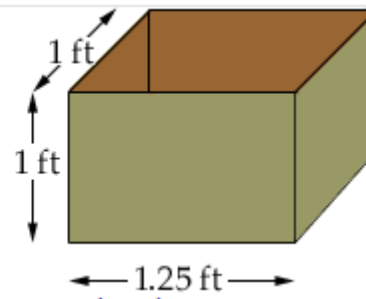

➤ **Weigh Batching:-**

- Batching by weight is more preferable to volume batching ,as it is **more accurate** and leads to more uniform proportioning.
- It does not have uncertainties associated with bulking.

➤ It's equipment falls into 3 general categories :

I. Manual,

II. Semi automatic,

III. Fully automatic.

1) In case of **manual batching** all weighing and batching of concrete are done manually. It is used for small jobs.

## 2) **Semi automatic:-**

- Using for large size works
- In it, the aggregate bin gates are opened by manually operated switches and gates are closed automatically when the material has been delivered.
- Contains interlock which prevents charging and discharging.



### 3) Fully automatic:-

- In it, the material are electrically activates by a single switch and complete autographic record are made of the weight of each material.
- This type plants is only suitable for the production of RMC to achieve proper mix .
- The batching plant comprises 2,3,4 or 6 compartment bins of several capacities.
- Over the conveyer belt ,the weigh batchers and discharging are provided below the bins.



**MIXING**

## ➤ **Mixing:-**

- The mixing should be ensured that the mass becomes **homogeneous , uniform in colour and consistency .**

- **Methods of Mixing :**

- 1.Hands(using hand shovels)
- 2.Stationary Mixers or Machine mixing
- 3.Ready mix concrete

- **Hand Mixing:-**

Mixing by hands using ordinary tools like, hand shovels etc.

This type of mixing is done for less output of concrete



## **Procedure:-**

1. Measured quantity of sand is spread evenly on platform.
2. Spread the measured quantity of cement on this sand and mix it till the colour of concrete mixture is uniform.
3. Spread the measured quantity of coarse aggregate on the platform with sand and cement. Now spread the mixture of cement and sand on the stack of aggregate and mix it at least 3 times.
4. Add 3 quarters of total quantity of water required and turn the material towards the centre with spades.

# Machine mixing/stationary mixing

## ADVANTAGES

- It produce concrete at much faster rate as compared to that with hand mixing
- It is **economical** in compared to hand mixing
- More **uniform colour** and more **uniform consistency** of concrete in comparison to hand mix
- The quantity of concert produces **in better**

## Stationary Mixers:-

- Concrete is sometime mixed at jobsite in a stationary mixer having a size of 9 cubic meter .
- These mixers may be of :
  1. Tilting type ,
  2. Non-Tilting type

### Tilting type mixer:-

- It consist a conical drum which rotates on an inclinable axis.
- It has only one opening.
- The drum charged directly and discharged by tilting and reversing the drum



## Tilting type mixer:-

### ADVANTAGES

- Mixer is satisfactory for mass of **low workability**
- **Bigger size** of aggregate can be used
- This mixer has **more efficient**

### DISADVANTAGE

- the certain amount of **mortar adheres** to the drum and is left out in the drum during discharge

## **Non tilting type mixer:-**

- The mixing drum is cylindrical in shape and revolves two – horizontal axis.
- It has opening on both sides.
- The ingredients are charged in from one opening.
- For discharging concrete chute is introducing to other opening operating a lever.

NON-TILTING DRUM MIXER



# Ready Mixed Concrete

- ready mixed concrete is proportioned and mixed off at the project site and is delivered to the construction area in a freshly mixed and unhardened state. It can be manufactured by any of the following methods
  - central-mixed concrete
  - Truck-mixed concrete



# Central mixed concrete

- Central-mixed concrete
  - Mixed completely in a stationary mixer
- Delivered in
  - Agitator truck
  - A non-Agitating Truck



# Agitator Trucks:-

- A vehicle carrying a drum or agitator body, in which freshly mixed concrete can be conveyed from the point of mixing to that of placing, the drum being rotated continuously to agitate the contents.
- **Advantages:** Operate usually from mixing plants.
- **Watch for:** Timing of deliveries should suit job organization.

Concrete crew and equipment must be ready onsite to handle concrete.

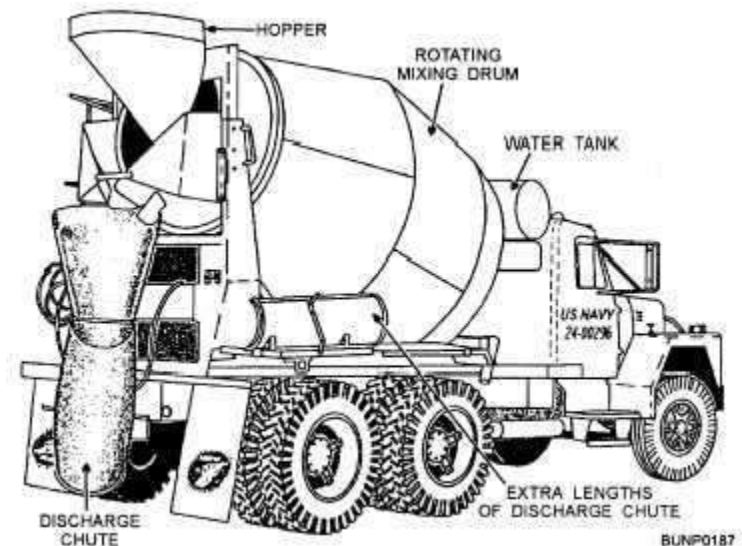

BUNP0187

# Non-agitating Trucks:-

**Used for:** Transport concrete on short hauls (small distance) over smooth roadways.

**Advantages:** Cost of non-agitating equipment is lower than that of truck agitators or mixers.

**Watch for:** Slump should be limited. Possibility of segregation. Height upon discharge is needed.



# Truck-mixed concrete :-

**Used for:** Intermittent (periodic) production of concrete at job site, or small quantities.

**Advantages:** Combined materials transporter and batching and mixing system. One man operation.



**TRANSPORT**

# Transporting

## Mortar Pan :

- It is labour intensive method
- Concrete is carried in small Quantities,
- No segregation takes place
- In hot weather, there is a substantial loss of water due to more exposure of concrete to environment.

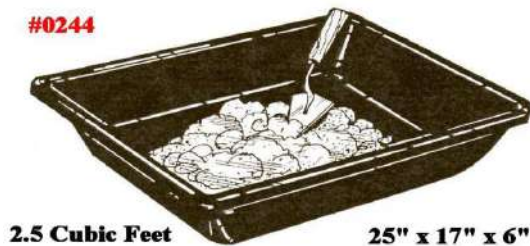

## 2 Wheelbarrows and Buggies:

- The capacity of wheel barrows varies from 70 to 80 litres.
- Suitable for concrete road construction where concrete is deposited at or below mixer level.
- Long haul due to uneven surface segregation takes place



**3) Bucket and rope way:** Conveying concrete horizontally or higher/lower level, suitable for work in valley, over high piers, long dam site



**4) Cranes and Buckets:** Used for Work above ground level, Buckets use with Cranes, cableways, and helicopters.



**5) Pumps:** Conveying concrete from central discharge point to formwork.(1.5 to 15 m<sup>3</sup>/hr)

- Horizontal distance of 400 vertical distance 80 m, pipe dia-80-200 mm
- Used for tunnelling lining,bridges,multistory buildings



**6) Transit Mixer:** Used for transporting the concrete over long distance particularly in RMC plant

- Capacity = 4 to 7 m<sup>3</sup>
- Segregation takes place in case  
Of delay



## 7) Chute

- Generally used for concreting in deep location.
- The slope should not be flatter than 1V:2.5H
- It is made up of or lined with metal.
- This is not good method of transporting concrete however, it is adopted, when movement of labour cannot be allowed due to lack of space



## 8) Skip and hoist

- It is a widely used method for high rise structures.
- Concrete is fed into the skip which travels vertically on rails like a lift.
- Normally used in 3 or 4 storeyed building construction



**PLACING**

# Placing of concrete

The process of depositing concrete in its required position is termed as **placing**. Concrete should be placed in systematic manner to get optimum results.

## **Precautions:- Placing concrete within earth mould**

**Concrete** is invariable as foundation bed below the walls and columns

before placing concrete

- All loose earth must be removed.
- Roots of trees must be cut.
- If surface is dry, it should be made damp.
- If it is too wet or rain soaked the water, then slush must be removed

## **Placing concrete in layers with in timber or steel shutter :-**

This can be used in the following cases:

Dam construction

Construction of concrete abutments

Raft for a high rise building

### **The thickness of layers depend on**

Method of compaction

Size of vibrator

Frequency of vibrator used

- It is good for laying 15 to 30 cm thick layer of concrete ,for mass concrete it may vary from 35 to 45 cm.
- It's better to leave the top of the layer rough so that succeeding layer can have the good bond.

## **Placing concrete with in usual form work:-**

- Adopted for column ,beam and floors rules that should be followed while placing the concrete.
- Check the reinforcements are correctly tied and placed.
- Mould releasing agent should be applied.
- The concrete must be placed carefully with a small quantity at a time so that they will not block the entry of subsequent concrete.

## **Placing concrete under water:-**

- Concrete having cement content at least 450kg/m<sup>3</sup> and a slump of 10 to 17.5cm can be placed underwater.

## **Methods:-**

- 1. Bagged method
- 2. Bottom dump method
- 3. Tremie
- 4. Grouted aggregate
- 5. Concrete pump

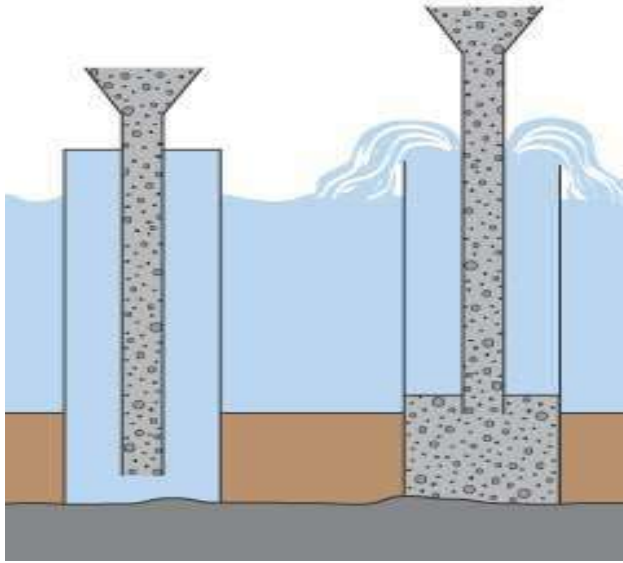

## **Placing Concrete Underwater:-**

**Used:** Tremie

**Advantages:** Can be used to funnel concrete down through the water into the structure.



**Watch for:** Discharge end always has to be buried in fresh concrete to ensure seal between water and concrete mass.

# COMPACTION

## Compaction of concrete:

- Compaction of concrete is process adopted for **expelling the entrapped air** from the concrete
- In the process of mixing , transporting and placing of concrete air is likely to get entrapped in the concrete .
- It has been found from the experimental studies **that 1% air in the concrete approximately reduces the strength by 6% .**
- If we don't expel this air, it will result into honeycombing and reduced strength

# **Different Methods Of Concrete**

## **Compaction:-**

### **1) Hand Compaction:**

- Rodding
- Ramming
- Tamping

### **2) Compaction by Vibration:**

- Internal vibrator
- Formwork Vibrator
- Table Vibrator
- Platform vibrator
- Surface vibrator .

## Hand Compaction:-

- Hand compaction is used for **ordinary and unimportant structures**. Workability should be decided in such a way that the chances of honeycombing should be minimum.

The various methods of hand compaction are as given below:

### Rodding:-

It is a method of poking with 2m long, 16 mm dia. rod at sharp corners and edges. The thickness of layers for rodding should be 15 to 20 cm.



## Ramming:-

- It is generally used for compaction on ground in plain concrete. It is not used either in RCC or on upper floors..



## Tamping:-

- It is a method in which the top surface is beaten by wooden cross beam of cross section 10 cm x 10 cm.
- **Both compaction and levelling are achieved simultaneously.**
- It is mainly used for roof slabs and road pavements.



## **Compaction by Vibration:**

- Vibration is imparted to the concrete by mechanical means.
- It causes temporary liquefaction so that **air bubbles come on to the top** and expelled ultimately.
- Mechanical vibration can be of various types as given under.

## **Internal Vibration:**

- It is most commonly used technique of concrete vibration.
- Vibration is achieved due to eccentric weights attached to the shaft.
- The needle diameter varies from 20 mm to 75 mm and its length varies from 25 cm to 90 cm.
- the frequency range adopted is normally 3500 to 5000 rpm.

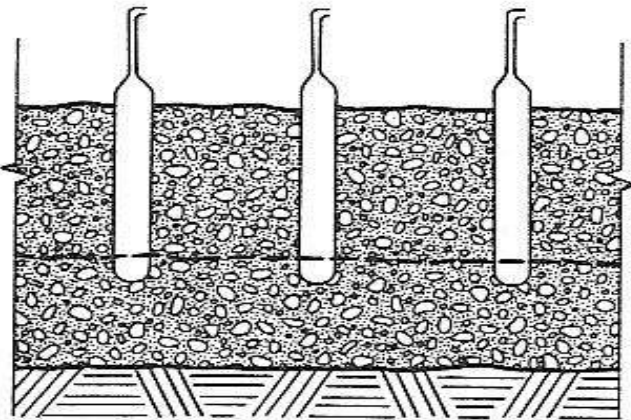

Correct

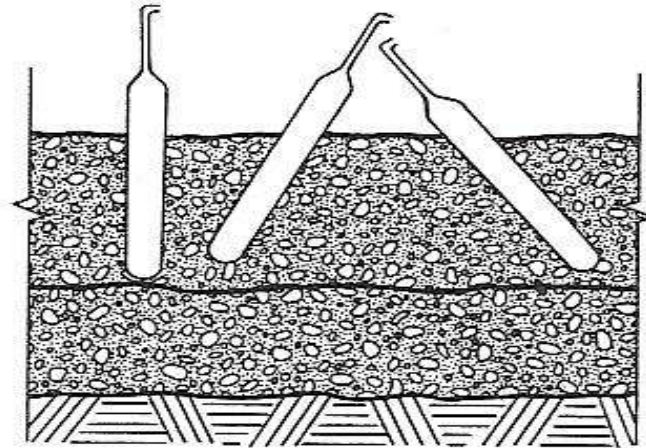

Incorrect

**Fig. 7.11:** Placing of poker vibrators  
(Based on *ACI Manual of Concrete Practice.*)

## External Vibration

- This is adopted where internal vibration can't be used due to either thin sections or heavy reinforcement.
- External vibration is less effective and it consumes more power as compared to the internal vibration.
- The formwork also has to be made extra strong when external vibration is used.



## Table Vibration:-

- It is mainly used for laboratories where concrete is put on the table
- They commonly used for vibrating concrete cubes



## Platform Vibration:-

- It is similar to table vibrators but these are generally used on a very large scale
- Used in the manufacture of large electrical poles, railway sleepers, prefabricated roof elements



## Surface Vibration:-

- These are also called screed board vibrators.
- The action is similar to that of tamping.
- The vibrator is placed on screed board and vibration is given on the surface.
- It is mainly used for roof slabs, road pavements etc., but it is not effective beyond 15 cm depth.



# Lack of compaction



**FINISHING**

## **FINISHING:-**

- The finish can be strictly functional or decorative.
- Finishing makes concrete attractive and serviceable.
- The final texture, hardness and joint pattern on slabs, floors, sidewalks, patios and driveways depend on the concrete's end use.



- Finishing may be defined as the process of levelling, smoothing, compacting and otherwise treating surface of fresh concrete or recently placed concrete to produce desired appearance.
- **STEPS INVOLVED FOR FINISHING CONCRETE**
- There are 3 different steps involved for finishing concrete, which are as given below.
- Screeding
- Floating
- Trowelling

# 1. SCREEDING (STEP-1)



- This is the process of striking off the excess concrete to bring the top surface to proper grade.
- While depositing concrete its thickness is kept slightly more than final finish. It is then moved by a ‘strike off’ board known as **screed**
- Aluminium screeder 3M length, 100mm wide

# Floating



- Floating consists in removing the irregularities on the surface of concrete which are left after screeding. This is done with a wooden float. It is about 1.5 m long and 20 cm wide, attached with a handle.
- In places where it is difficult to operate a long handle float, a wooden float 60 cm long and 10 to 12 cm wide with a handle can be used.

- **Trowelling**



- It is the final operation of finishing. It provides a smoother finish which is hard and abrasion resistant.
- It should be done after all excess water has evaporated.
- Trowelling with a steel float when the concrete is almost dry gives a very smooth finish.
- The trowel is 25 to 50 cm long and 8 to 12 cm wide.

**CURING**

## Curing:-

- **Curing** is the process in which the **concrete** is protected from loss of moisture and kept within a reasonable temperature range.
- The result of this process is increased strength and decreased permeability.
- **Curing** is also a key player in mitigating cracks in the **concrete**, which severely impacts durability.



## **Curing:-**

- Curing can be defined as a procedure for insuring the hydration of the Portland cement in newly-placed concrete.
- It generally implies control of moisture loss and sometimes of temperature.

## **Need for curing:-**

- Causes Hydration reaction of cement with water.
- Loss of water by evaporation can be prevented.
- Maintain conductive Temperature .
- For completing of Hydration reaction.
- For capillary segmentation .

# **Methods of curing:-**

## **WATER CURING**

1)Immersion 2) Ponding 3) Spraying 4) Wet covering

## **MEMBRANE CURNING**

## **APPLICATION OF HEAT**

## Immersion:-

- The precast concrete items are normally immersed in curing tanks.
- The cement and concrete test tubes, cylinders, beams etc. In the test laboratories are cured by immersion.



## **Ponding:-**

- Pavement slabs, roof slab etc. are covered under water by making small ponds.
- Fig: Ponding of slab



## **Spraying :-**

- Vertical retaining wall or plastered surfaces or concrete columns etc. are cured by spraying water.



## Wet covering:-

- In case of sprinkling the water method curing it is difficult to ensure that all the parts of concrete be moist all the time
- Sometimes the vertical or inclined concrete members covered with Wet gunny bags, hessian cloth, jute matting, straw etc, are wrapped to vertical surface for keeping the concrete wet.



Covering with gunny bag



curing with water proof paper

## Membrane curing:-

- In it, concrete is covered with membrane which effectively **seal off the evaporation** of water from concrete.
- It is carried out at the interface of the ground and concrete to prevent the absorption of water by the ground from the concrete.
- Membrane curing maintains a satisfactory state of wetness in the body of concrete to promote continuous hydration when original water/cement ratio used is not less than 0.5.



## **Application of heat:-**

- The development of strength of concrete is a function of not only time but also that of temperature. When resulting in faster development of strength.
- Subjecting the concrete to higher temperature and maintaining the required wetness can be achieved by subjecting the concrete to **steam curing**.

### **• TYPES OF HEATING CURING**

- Steam curing at ordinary pressure
- Steam curing at high pressure
- Curing by infra-red radiation
- Electrical curing

# STEAM CURING AT ORDINARY PRESSURE:-

This method is often adopted by **prefabricated concrete elements**.

- At some places it has been useful with the help of thick polyethylene sheets,
- With steam curing the strength development of concrete is very rapid.
- One day strength of concrete steam cured can be equal to 28 days strength of normal cured concrete.
- The concrete mixes with water cement ratio range from 0.3 to 0.7 can be cured by steam curing.



# Infrared curing

- Infrared radiation is done in very cold regions in Russia.
- It is claimed that much more rapid gain of strength can be obtained **even with steam curing**.
- This system described as particularly applicable to the manufacture **of hollow concrete products** in which the heaters are placed in the hollow spaces of the product.
- The normal operative temperature is 90 C



# Electrical Curing

- this method is also used in very cold climate regions.
- In this method the concrete is cured by passing an **alternate current through concrete itself** between 2 electrodes either buried in or applied to the surface of the concrete
- Evaporation is prevented by using impermeable rubber membrane on the top surface of concrete
- The duration of electrical curing should be about 48 hrs at the temperature of 50 C or 36 hrs at the temperature of 70 C
- by electrical **curing 28 days strength can be obtained in 3 days**

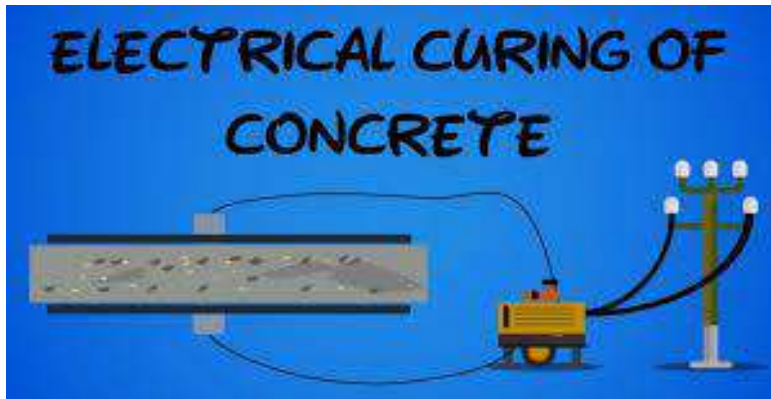

# Accelerated curing

- Accelerated curing is any method by which **high early age strength is achieved in concrete.**
- These techniques are especially useful in the prefabrication industry, where in high early age strength enables the removal of the formwork within 24 hours
- This method is also used to find out 28 days compressive strength of concrete in **28 hours**



# GOOD AND BAD PRACTICES OF MAKING AND USING FRESH CONCRETE

## Do's

- Do hire an **experienced concrete contractor** for successful concreting operation
- Start placement of concrete with adequate manpower, proper equipment and tools
- Always choose **right cement** for particular job, if u have confusion, ask the technical person
- Always pour the concrete when the **weather condition are favourable**
- **Suitable mix design** should be used for particular specification
- **Add water** as per predetermined quantity only

- Mix the wet concrete thoroughly for **around 2 minutes** to get the consistence concrete
- **Do slump** test before placing the concrete
- Concrete must be placed within **15 to 20 min** of pouring water
- Pour the concrete throughout in an **even thickness**
- Always keep on checking the stability of **props/supports** of formwork below
- Finish the surface and edges of concrete after placing of concrete using with **trowels or wooden floats or metal floats.**
- See that **no one walks** on the concrete surface till the concrete gets hardened

## Don'ts

- Don't use **damaged formwork**.(honeycomb)
- Don't use **unwashed aggregates** in concrete: it may results in a weak concrete and substantial cost of maintenance.
- Don't start concreting before casting of concrete cubes. The strength of concrete should be as per predetermined mix design
- Don't go for **volumetric batching**.Never allow the use of gamellas
- Don't use high **concrete slump**, excessively high air content, or excessive fines.
- Don't run concrete mixer **more than 2 min** (segregation)
- Don't **add more water** for ease of placement during the making of concrete.

- **Don't drop concrete from greater height** as will cause segregation.
- Don't allow heaping of concrete at one place during pouring
- **Don't vibrate the concrete** after the initial setting has taken place
- **Don't finish** the concrete while bleeding is present on the surface of concrete
- **Don't remove formwork** until concrete has gained sufficient strength . As per IS 456:2000
- Don't try to finish the dried concrete
- Don't do concreting if it is raining heavily.

# MASS CONCRETE

- Mass concrete can be defined as any volume of concrete with dimensions large enough to require measures to be taken to cope with the generation of heat from hydration of the cement and attendant volume change to minimize cracking in other words, the concrete placed in massive structures like dams, canals, bridge pier etc.. Can be termed as mass concrete



- The heat of hydration is the **heat generated** due to hydration of cement i.e. due to reaction between **cement particles and water**.
- It is **critical to measure heat of hydration in mass concrete work**. As huge volume of concrete is poured in constructing large structures such as dams.
- there is **thermal gradient induced** due to higher rate of loss of heat from outer surface than from inner core.
- This thermal gradient causes **cracking in concrete** due to non-uniform expansion of concrete within the body.
- And as we know that cracking is dangerous due to many reasons like **reduced strength, durability, water tightness and many more**

## **It can be controlled by following ways:**

- Using low heat cement
- Using cement with pozzolanic admixtures preferably fly ash or slag. Silica fume can not reduce heat of hydration.
- Concreting by blocks.
- Using ice instead of water to prepare concrete.
- Constantly monitoring thermal gradient.
- Covering concrete as soon as it is casted to reduce loss of heat and hence reduce thermal gradient

THANK U



|| Jai Sri Gurudev ||



Sri Adichunchanagiri Shikshana Trust ®  
**S J C INSTITUTE OF TECHNOLOGY**  
**CHICKBALLAPUR – 562 101, Karnataka**

(Affiliated to VTU, Belagavi & Approved by AICTE, New Delhi, NBA Accredited and ISO  
9001: 2008 Certified)

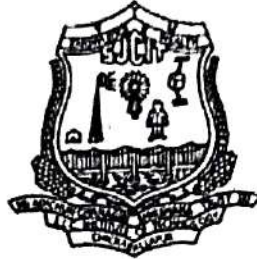

**“Industrial Visit-2019”**

**“ULTRA TECH RMCPLANT ATYELAHANKA BANGLORE”**

**For**

**4<sup>th</sup> Semester B sec Civil Engineering Students**

**29<sup>th</sup> April 2019**

**ORGANISED BY**

**DEPARTMENT OF CIVIL ENGINEERING**

As the civil engineers comprise the combine outcome of theory and practical knowledge. Hence department is always in the search of excellent field visits. A one day educational industrial visit arranged for the students of IV semester 'B' section on 29<sup>th</sup> April 2019 to make them more inclined towards the field knowledge.

**Objective of Visit:** Technical exposure of Concrete Technology, Manufacturing Processes and other Engineering aspects of Concrete Technology Subject.

First a technical Explanation by Plant Supervisor, he explained us regarding the Concrete Mix Plant Capacity, Transit Mixer, Material used in Concrete, Testing Unit of Concrete, Compressive Strength of Concrete, Curing Tank for Curing of Concrete, Design parameters, etc. He also shared some Knowledge about their Experience regarding to Concrete Mix.

**Escorting Staff**

Prof.Kiran K M

Prof. Chetan G N

**List of Students Participated**

S.No	USN	Student Name
1	1SJ17CV046	PADMARAJ
2	1SJ17CV047	PALLAVI J
3	1SJ17CV048	PAVITHRA R
4	1SJ17CV049	PRAMOD SIDDARTH D
5	1SJ17CV051	PRATIBHA PATIL
6	1SJ17CV052	PRAVALIKA A
7	1SJ17CV053	PRIYANKA S B
8	1SJ17CV054	PRUTHVI CHANDRA K N
9	1SJ17CV055	PURUSHOTHAM S
10	1SJ17CV056	R CHANDANA
11	1SJ17CV057	RAKESH S
12	1SJ17CV058	RAKSHITA K A
13	1SJ17CV059	RANJITH P
14	1SJ17CV060	RANJITHA R
15	1SJ17CV061	RAVI BILAWAR
16	1SJ17CV062	ROOPA T S
17	1SJ17CV063	S PRAJWAL
18	1SJ17CV064	SACHIN JAISWAL
19	1SJ17CV067	SHASHIKALA M
20	1SJ17CV068	SHRAVANI K P
21	1SJ17CV069	SHRAVANTHI T N
22	1SJ17CV070	SINDHU M
23	1SJ17CV071	SRISHA A R
24	1SJ17CV072	SUVEK M
25	1SJ17CV073	TIMMAREDDY

26	1SJ17CV074	VARSHINI M
27	1SJ17CV075	VARUN GOWDA M
28	1SJ17CV076	VENKATESH S
29	1SJ17CV077	VINOD KUMAR
30	1SJ17CV079	VIRESH
31	1SJ17CV080	YASHASWINI C
32	1SJ17CV081	YASHWANTH R
33	1SJ17CV082	YOGESH S
34	1SJ17CV083	AMULYA R
35	1SJ17CV084	BHOOMIKA K R
36	1SJ17CV086	CHIRAG H N
37	1SJ16CV022	E MANJUNATH GOWD
38	1SJ16CV088	RUCHITHA B R
39	1SJ16CV124	YOGESH N
40	1SJ16CV099	SHAIK NOOR MOHAMMED
41	1SJ18CV405	BHOOMIKA H O
42	1SJ18CV410	DIVYA V
43	1SJ18CV412	GOKARNA Y J
44	1SJ18CV400	ADARSHA J
45	1SJ18CV402	ARUN KUMAR T A
46	1SJ18CV414	HARSHAVARDHANA C M
47	1SJ18CV415	JAYARAMA M
48	1SJ18CV416	K DEVARAJ GOWD
49	1SJ18CV417	KESHAVA MURTHY
50	1SJ18CV419	MADHUSUDHAN S
51	1SJ18CV420	MONICA A L
52	1SJ18CV421	NAKUL Y K
53	1SJ18CV422	NAVEEN A
54	1SJ18CV423	PAVAN KUMAR B O
55	1SJ18CV424	PAVAN KUMAR N V
56	1SJ18CV425	SANJAY H V
57	1SJ18CV426	SRINIVAS M
58	1SJ18CV427	SYEDA SABA KOUNAIN
59	1SJ18CV428	TAYAPPA
60	1SJ18CV429	TEJAS G
61	1SJ18CV430	THRIVENI R
62	1SJ18CV431	VARUN S
63	1SJ18CV432	VASUDEVA BAYARI R
64	1SJ18CV433	VINAYAKUMARI T
65	1SJ18CV434	IRFAN BASHIR

### Outcomes

Students have learnt Process of concrete, Material used in concrete mix, Test conducted over Concrete Blocks, Curing process for Concrete Blocks etc. With this kind of industrial visit, we gained more knowledge on Concrete Technology application aside from the theoretical aspect learned from the classrooms and laboratory.

### Photos of the Places visited

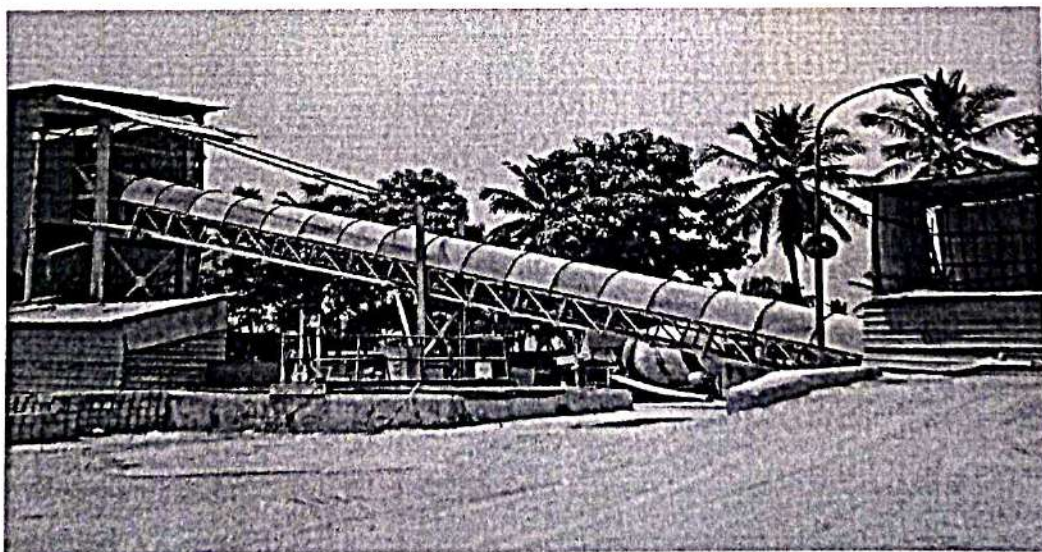
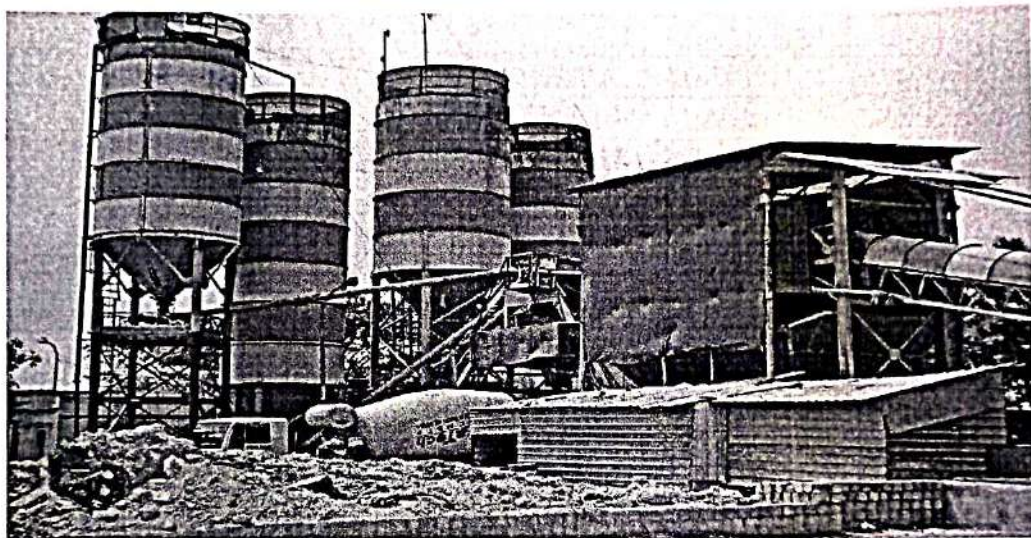

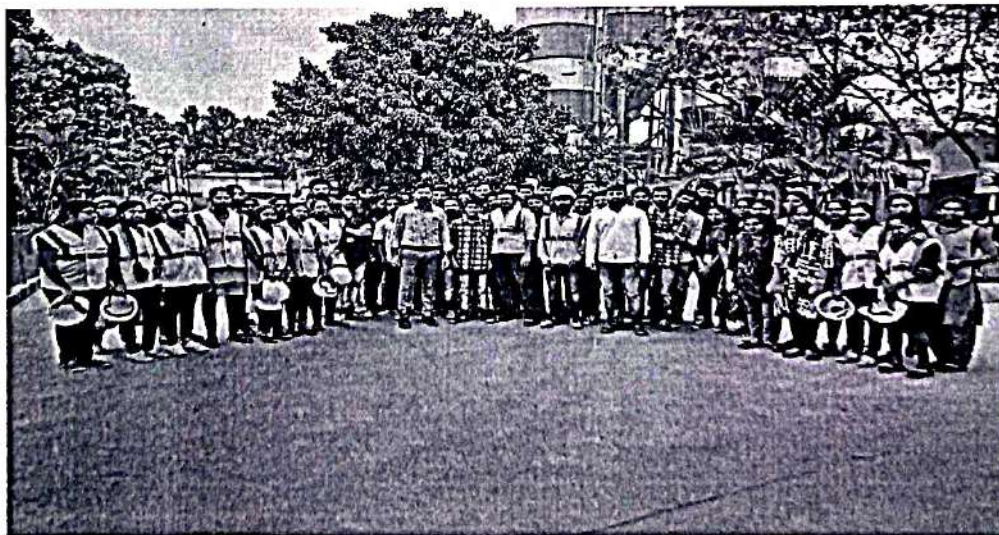
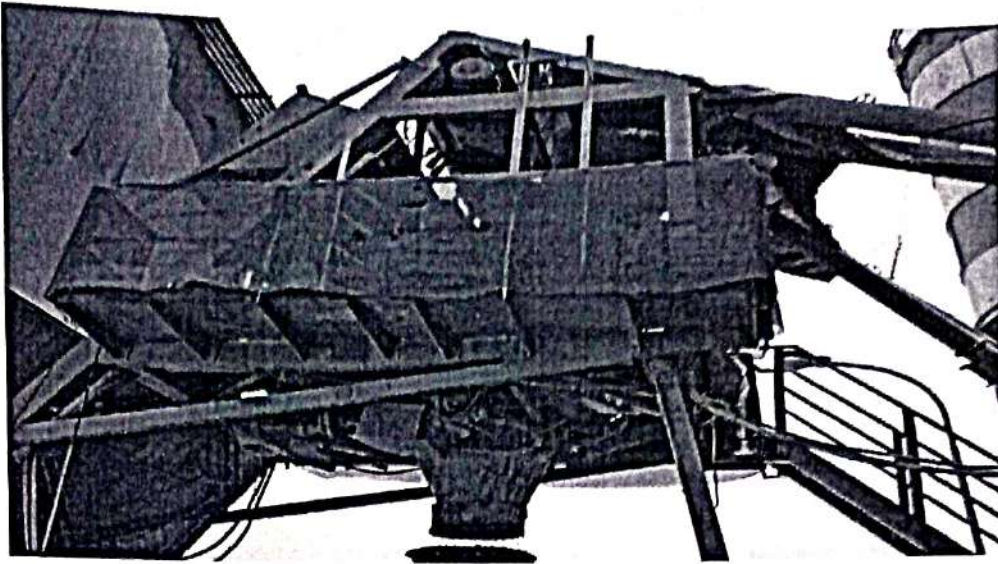



Prof. Kiarn K M and Prof. Chetan G Nalong with 4<sup>th</sup> sem 'B' section students visited ULTRA TECH CEMENT, RMC PLANT at Yelahanka, Bangalore.

  
13/5/2019  
PROFESSOR & HEAD  
Dept. of Civil Engineering  
SJC Institute of Technology  
CHICKBALLAPUR-562101

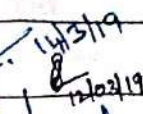
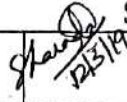
**Internal Test Question paper format- CBCS Scheme**

Name of the staff/s: Dr G Narayana & Sushma M	Signature: 
Date: 12/03/19	
Reviewer's Signature: 	

**S.J.C. Institute of Technology**

Department: Civil Engineering.

Test: I

Semester: IV Section: 'A' &amp; 'B'

Subject Name & Code: concrete technology (17CV44)  
minutes

Max Marks: 30

Duration: 90

Answer the following questions.

Q.No	Questions	M	CO	Levels
1	a Explain the phenomenon of hydration of cement and its effect on strength of concrete.	5	CO1	L2
	b What are the various types of admixture used in concrete? Explain in details effect of super-plasticizers on concrete.	5	CO1	L1
<b>OR</b>				
2	a Explain the importance of size, shape and texture of aggregate	5	CO1	L2
	b What are the tests usually conducted on cement in the laboratory, explain any one test.	5	CO1	L1
3	a Explain the method of compaction of concrete during concrete surface finishing.	5	CO2	L2
	b Explain the importance of cement ingredients.	5	CO1	L2
<b>OR</b>				
4	a Explain the ill-effects of segregation and bleeding in concrete.	5	CO2	L2
	b Explain the manufacturing process of cement by dry process along with flow chart.	5	CO1	L2
5	a Explains the various methods of transportation and placing of concrete used for making good quality concrete?	10	CO2	L2
<b>OR</b>				
6	a Explain factors affecting workability of concrete in detail..	10	CO2	L2

CO1	15	CO2	15	L1	05	L2	25
-----	----	-----	----	----	----	----	----

\*\*\*\*\*ALL THE BEST\*\*\*\*\*



DEPARTMENT - Civil Engineering

Scheme & Solutions- TEST - II/III

Date: 12/03/2019

Semester: 4<sup>th</sup>

Subject Title: Concrete Technology

Subject Code: 170144

Question Number	Solution	Marks Allocated
Q1a)	<p>phenomenon</p> <p><math>C_3S + H_2O \rightarrow</math> Hydrated calcium silicate + <math>Ca(OH)_2</math></p> <p><math>C_2S + H_2O \rightarrow</math> Hydrated calcium silicate + <math>Ca(OH)_2</math></p> <p><math>C_3A + H_2O \rightarrow</math> Hydrated calcium silicate + <math>Ca(OH)_2</math></p> <p>effects on strength on concrete</p>	<p>(03)</p> <hr/> <p>(02)</p> <hr/> <p>05M</p>
Q1b)	<p>Chemical admixture <math>\rightarrow</math> plasticizers, super plasticizers, Retarders, Accelerators</p> <p>Mineral admixture <math>\rightarrow</math> Flyash, GGBS, Rice husk silica fume</p> <p>detailed explanation on super-plasticizers on concrete</p>	<p>(2½)</p> <hr/> <p>(2½)</p> <hr/> <p>5M</p>
(OR)		
Q2a)	<p>Size <math>\rightarrow</math> coarse aggregate, Fine aggregate</p> <p>Shape <math>\rightarrow</math> Rounded, Irregular, Flaky &amp; elongation</p> <p>Texture <math>\rightarrow</math> smooth surface, Rough surface texture</p>	<p>5*1=5M</p>
Q2b)	<p>List the Test.</p> <p>sieve analysis, field Test, consistency Test, soundness Test etc</p> <p>Explanation any one in detail</p>	<p>(02)</p> <hr/> <p>(03)</p> <hr/> <p>05M</p>



DEPARTMENT

Scheme & Solutions- TEST- I/II/III

Date: 12/08/19

Semester: IV

Subject Title: Concrete Technology

Subject Code: 17CV44

Question Number	Solution	Marks Allocated
03a)	<p>methods of compaction,</p> <ul style="list-style-type: none"> <li>↳ Hand compaction</li> <li>↳ Mechanical compaction               <ul style="list-style-type: none"> <li>a) needle vibrators</li> <li>b) surface vibrators</li> <li>c) plate form vibrator</li> <li>d) screed vibrator</li> </ul> </li> </ul> <p style="text-align: right;">} Explain</p>	05 * 1 = 5M
03b)	<p>Impurities cement ingredients</p> <p>List → Lime - 60 to 67%          silica - 17 to 25%          Alumina → 3 to 8%          Iron oxide - 0.5 to 6%          magnesia → 0.1 to 4%</p> <p style="text-align: right;">} Explain</p>	05M
(04a)	<p>(013)</p> <p>ill-effects of segregation</p> <p>ill-effects of bleeding.</p>	$2\frac{1}{2}$ $2\frac{1}{2}$
(04b)	<p>Dry process with flow chart</p> <p>Explanation with brief</p>	<hr/> 5M 3M <hr/> 2M <hr/> 5M



Question Number	Solution	Marks Allocated
050)	<p><u>Methods of Transportation</u></p> <ul style="list-style-type: none"> <li>* Pum motor</li> <li>* wheel. burrows</li> <li>* Tipper Trucks</li> <li>* concrete pumps</li> <li>* chuce</li> <li>* vases &amp; Buckets</li> <li>* skip &amp; hoist</li> </ul> <p><u>Methods of Placing</u> * Bagged, Bottom clamp, Tremie, Grouted aggregate, Concrete pump</p>	<p style="text-align: right;">(05)</p> <p style="text-align: right;">(05)</p> <hr style="width: 50px; margin-left: auto; margin-right: 0;"/> <p style="text-align: right;">10M</p>
06)	<p><u>Factors affecting workability</u></p> <ul style="list-style-type: none"> <li>→ water content</li> <li>→ Mxc proportion</li> <li>→ size of Aggregate</li> <li>→ shape of Aggregate</li> <li>→ grading of Aggregate</li> <li>→ use of admixture</li> <li>→ Temperature</li> </ul> <p style="text-align: center;">Explanation</p>	<p style="text-align: right;">(03)</p> <p style="text-align: right;">(04)</p> <hr style="width: 50px; margin-left: auto; margin-right: 0;"/> <p style="text-align: right;">10M</p>

Shanida  
12/5/19



### Internal Test Question paper format- CBCS Scheme

Name of the staff/s: Dr G NARAYANA & Ms. SUSHIMA M

Date: 11.04.2019

Signature: 11/04/19

Reviewer's Signature: 11/04/19

NOTE: Only the following information's to be given to the students

**S.J.C. Institute of Technology**

Department: CIVIL ENGINEERING

Test: II

Semester: IV Section: A, B

Year: 2018-2019

Duration: 90 minutes

Subject Name: CONCRETE TECHNOLOGY

Subject Code: 17CV44

Max Marks: 30

**INSTRUCTIONS:** i) Answer *TWO* full questions, choosing *ONE* full question from each part.

Q.No.	PART A	Marks	CO	Levels
1.a	What are the different factors which influences creep of concrete?	10	CO3	L2
b	Explain the methods for controlling sulphate attack on concrete.	5	CO3	L2
<b>OR</b>				
2.a	What is shrinkage? Explain the factors affecting shrinkage of concrete.	10	CO3	L2
b	Write a short note on following: 1) Gel space ratio 2) Modulus of elasticity	5	CO3	L2
<b>PART B</b>				
3.a	Compare the difference between Insitu concrete & Ready mixed concrete.	10	CO4	L2
b	Explain the process of disintegration of concrete due to carbonation of concrete.	5	CO3	L2
<b>OR</b>				
4.a	What is Ready mixed concrete? State advantages & disadvantages of Ready mixed concrete	10	CO4	L2
b	Explain in detail the factors affecting strength of concrete	5	CO3	L2

**Note:** The choice questions should satisfy same COS & Levels

CO1=0	CO2=10M	CO3=20M	CO4=10M	CO5=0	L1=0	L2=30M	L3=0	L4=0	L5=0	L6=0
-------	---------	---------	---------	-------	------	--------	------	------	------	------



DEPARTMENT OF CIVIL ENGINEERING

Schemo & Solutions- TEST- I/III/III

Semester: 4<sup>th</sup>

Subject Title: Concrete Technology

Subject Code: 17CV44

Question Number	Solution	Marks Allocated
1a.	<p style="text-align: center;"><u>PART-A</u></p> <p>factors affecting creep of concrete</p> <p><u>List</u></p> <ul style="list-style-type: none"> <li>* concrete mix proportion</li> <li>* Aggregate proportion</li> <li>* Age at loading</li> <li>* curing conditions</li> <li>* cement properties</li> <li>* Temperature</li> <li>* stress level</li> </ul> <p>explain each briefly</p>	10
1b.	<p>methods of controlling sulphate attacks</p> <ul style="list-style-type: none"> <li>* use of sulphate resisting cement</li> <li>* addition of Pozzolana</li> <li>* use of air-entrainment</li> <li>* quality of concrete</li> <li>* High pressure steam curing</li> </ul>	05



Subject Title: Concrete Technology

Question Number	Solution	Marks Allocated
2a)	<p style="text-align: center;">(a)</p> <p>Definition of shrinkage</p> <p>factors affecting shrinkage</p> <ul style="list-style-type: none"> <li>* Aggregate</li> <li>* water-cement ratio</li> <li>* Type of cement</li> <li>* Admixtures etc</li> </ul>	10
2b)	<p>Short note on</p> <ul style="list-style-type: none"> <li>(i) Gel-space ratio</li> <li>(ii) modulus of elasticity</li> </ul>	05
<u>PART-B</u>		
3a)	<p>difference b/w site mix &amp; B.M.C</p>	10
3b)	<p>Carbonation process</p> <p>measure for controlling chloride attack</p> <ul style="list-style-type: none"> <li>* Reduce permeability</li> <li>* Improve curing</li> <li>* Addition of admixtures</li> <li>* Polymer modification</li> </ul>	05

Dr. K. M. Kavitha

Subject Title: Concrete Technology

Subject Code: 17CV44

Question Number	Solution	Marks Allocated
4a)	<p style="text-align: center;">(2)</p> <p>definition of Ready Mix concrete</p> <p>Advantage of RMC</p> <p>disadvantage of RMC</p>	10
4b)	<p>factors affecting strength of concrete</p> <ul style="list-style-type: none"> <li>* w/c ratio</li> <li>* compaction of concrete</li> <li>* curing of concrete</li> <li>* The shape of Aggregate</li> <li>* Grading of Aggregate</li> <li>* Temperature</li> </ul>	05

Sharda  
11/04/19

Sharda  
11/04/19

# CBCS SCHEME

USN

1 S J 1 7 C V 0 0 8

17CV/CT44

Fourth Semester B.E. Degree Examination, June/July 2019

## Concrete Technology

Time: 3 hrs.

Max. Marks: 100

Note: Answer any FIVE full questions, choosing ONE full question from each module.

### Module-1

- 1 a. Explain the constituents of cement with their percentage and functions. L2 (10 Marks)  
b. Define Fineness modulus. Explain test procedure to determine the Fineness modulus and Importance of Fineness modulus. L2 (10 Marks)

OR

- 2 a. What are Bogue's compounds? Briefly explain their contribution towards gaining of strength of cement with graph. L2 (10 Marks)  
b. What is an Admixture? What are the effects of air entrainment and Retarders on the properties of concrete? L1 (10 Marks)

### Module-2

- 3 a. Define Workability. Briefly explain the factors which affects the workability of concrete. L2 (10 Marks)  
b. What is the Importance of curing in concrete? Briefly discuss any two methods. L2 (10 Marks)

OR

- 4 a. Mention the various stages of manufacturing of concrete. Discuss any two stages. L2 (10 Marks)  
b. Explain good and bad practices of making and using fresh concrete. L2 (10 Marks)

### Module-3

- 5 a. Explain the factors affects the strength of concrete. L2 (10 Marks)  
b. Write short notes on : i) Shrinkage of concrete ii) Creep. (10 Marks)

OR

- 6 a. What is durability of concrete? Explain the factors affecting the durability of concrete. L2 (10 Marks)  
b. Mention various non-destructive testing of concrete. Explain any two methods in brief. L2 (10 Marks)

### Module-4

- 7 Design a concrete mix for M<sub>25</sub>. L6  
a. Grade designation : M<sub>25</sub>  
b. Type of cement : OPC 43 grade  
c. Max. Nominal size of aggregates 20mm down  
d. Min. cement content : 300 kg/m<sup>3</sup>  
e. Water cement ratio : 0.50  
f. Workability : 75mm slab  
g. Exposure condition : Moderate (RCC)  
h. Method of concrete placing : Manual  
i. Max. cement content : 450 kg/m<sup>3</sup>  
j. Chemical admixture : NIL  
k. Fine aggregate zone : Zone 2.

A Cement : Type of cement = OPC 43 grade  
Specific gravity : 3.15

Important Note : 1. On completing your answer, compulsorily draw diagonal cross lines on the remaining blank pages.  
2. Any revealing of identification, appeal to evaluator and/or equations written eg. 42+8 = 50, will be treated as malpractice.

B Coarse Aggregate : Specific gravity : 2.80  
Water absorption : 1%  
Free surface moisture : NIL

C Fine Aggregate : Specific gravity : 2.65  
Water absorption : 2%  
Free surface moisture : 2%

D Chemical Admixture - NIL.

(20 Marks)

OR

8 Discuss the concept of mix design. Write step by step procedure for mix design using IS code. Also discuss the variables in proportioning of concrete.

(20 Marks)

Module-5

9 a. What are requirements of RMC according QCI? Briefly discuss advantages and disadvantages of RMC.

(10 Marks)

b. What is Light weight concrete? Discuss the uses and advantages of Light weigh concrete.

(10 Marks)

OR

10 a. Enumerate the benefits of self compacting concrete. Explain any two test on self compacting concrete.

(10 Marks)

b. List the types of Fibres used in FRC and discuss Factors affecting properties of FRC.

(10 Marks)